

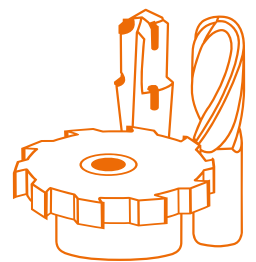

VGrind 360S

////// ROTARY TOOLS //

Grinding machine for the complete machining
of carbide tools up to 200 mm in diameter



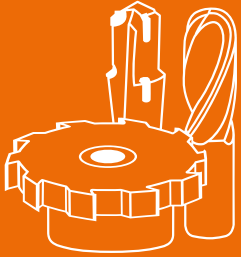

///// ROTARY TOOLS // CARBIDE GRINDING

FINE GRINDING
WITH UTMOST
PRECISION.

The **VGrind 360S** – the new standard for the complete machining of solid carbide tools of up to 200 mm. Ideal for applications in the areas of automotive manufacturing, toolmaking, medical technology, precision engineering, aeronautical engineering and many more.

What sets this grinding machine apart is that it has more precision and power thanks to its innovative linear induction motor on the X, Y and Z axes. This allows you to use the vertical multi-layer machining to bring all of the machine's assets to the fore – with magnets, without making contact and without wear. This results not only in excellent performance, but also less maintenance required.

What you get: Optimal surface quality thanks to a five-axis grinding machine which impresses with every detail – from the operating concept to the intuitive software and clever automation solutions.

VGrind 360S – FOR INCREASED PRECISION AND PERFORMANCE



1 TORQUE

Higher torque at the bottom spindle for powerful fluting operations and an increased material removal rate.

2 MODERN OPERATING CONCEPT

Height-adjustable, with touchscreen, 19" diagonal screen size and optimum view into the machining chambers.

3 WALL CONCEPT

Very rigid, compact construction with optimal accessibility and overview for the operator.

4 MULTI-LAYER MACHINING

Two vertical grinding spindles with the grinding wheel set at the C axis pivot point. Reduced machining times thanks to shorter linear-axis travel distances.

5 LINEAR INDUCTION MOTORS

Linear induction motors on the X, Y and Z axes allow for high precision and energy without wear.

6 NUMROTOplus®

The reliable, intuitively operated software with 3D tool and machine simulation, combined with collision monitoring.

7 GRINDING WHEEL CHANGER

Provides even more flexibility in your manufacturing processes – with eight HSK-50 grinding wheel sets. Both grinding spindles can be loaded with complete flexibility.

8 AUTOMATION

The VOLLMER HP 170 pallet magazine, the HPR 250 free-arm robot or the HC 4 and HC 4 plus chain magazines automatically ensure increased capacity and flexibility.



////// PIVOT POINT FOR GRINDING WHEEL SETS
located in the centre of the C axis

// THE MACHINE CONCEPT

Precision and efficiency squared: This principle is also followed by the *VGrind 360S* – thanks to two vertically arranged grinding spindles. In addition, its effective cooling concept has now been optimised and extended. The result: Maximum perfection at the lowest tolerances with the best possible cooling.

/// Five-axis CNC grinding machine with innovative kinematics

/// Two grinding spindles situated one above the other with the grinding wheel set positioned at the C axis pivot point – to ensure extremely precise grinding results

/// The vertical spindle arrangement solves the well-known problems related to fixed and floating bearings

/// Higher torque at the bottom spindle for fluting operations



/// Wear-free linear induction motors on the X, Y and Z axes not only guarantee lasting consistency of quality and lower maintenance costs, but are also the key to improved surface quality

/// Innovative wall concept with the highest possible rigidity and outstanding damping thanks to polymer concrete

/// The innovative heat exchanger effectively cools the motors and spindles. This increases the thermal stability and optimises precision and performance in the long term

/// Both spindles can be fitted with multiple different grinding wheel configurations. The automation option ensures seamless conversion

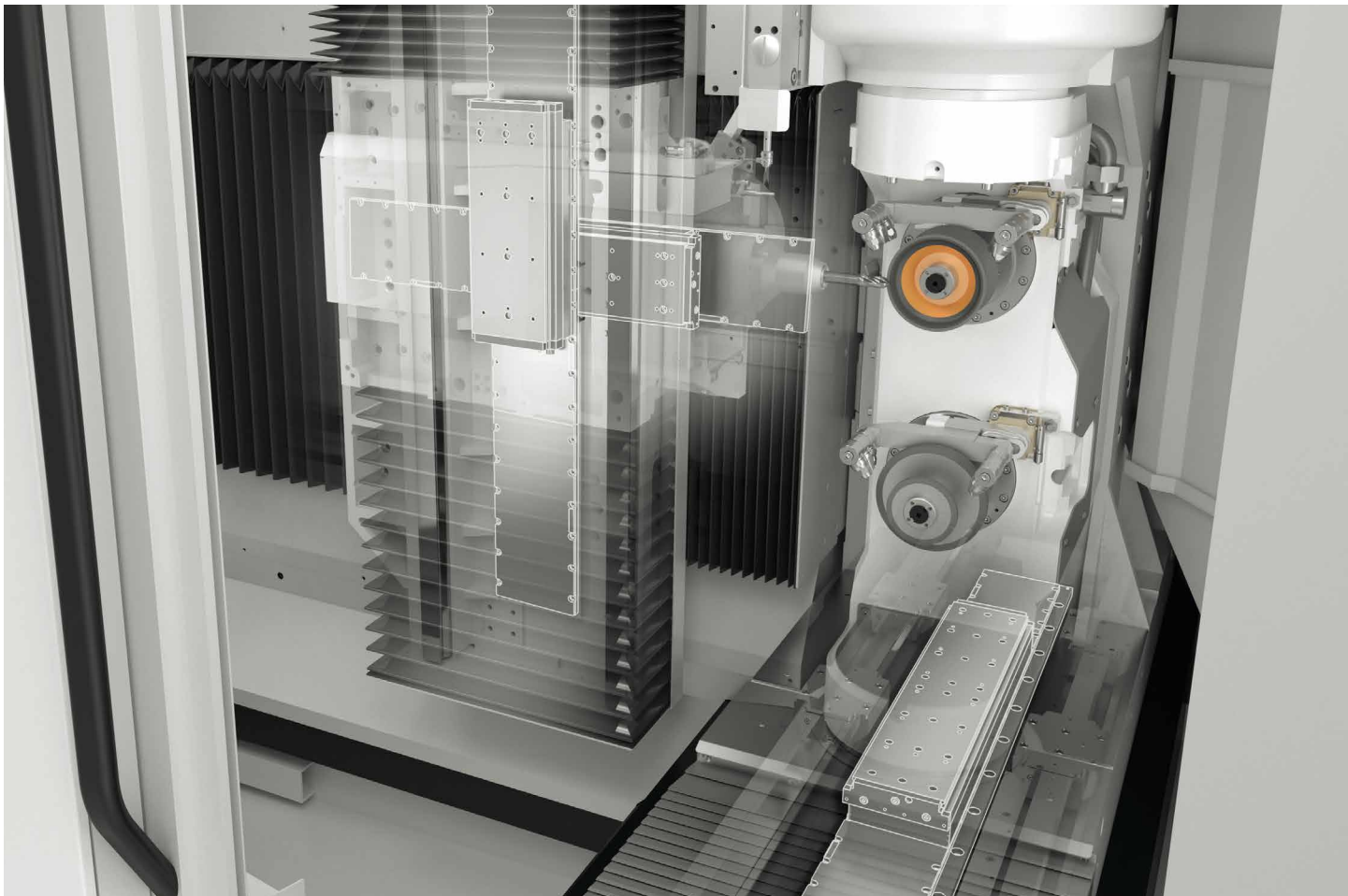

////// LINEAR INDUCTION MOTORS
On the X, Y and Z axes



// THE MACHINE CONCEPT

OPTIONAL EQUIPMENT

- /// Flexible automation options for carbide tools
- /// Grinding spindle available with direct or belt drive
- /// Automatic changing of grinding wheel sets complete with coolant nozzles for optimum productivity

///// COOLANT NOZZLES
For optimum coolant supply



///// GRIPPER COMPENSATION
Safe, precise loading and unloading

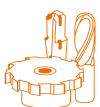

///// ROTARY TOOLS // CARBIDE GRINDING



///// STICKING UNIT
for opening the abrasive grinding wheel

/// Automatic gripper compensation as an in-process solution: Maximum precision when loading and unloading tools for decreased wear and optimal radial run-out

/// Wheel compensation probe: Grinding wheel alignment and wear control within the machine

/// Automated changing of intermediate sleeves with bayonet

/// Automatic sticking unit enables the abrasive grinding wheel to be opened during the grinding process

/// Simultaneous grinding wheel package and tool change in combination with the HP 170 pallet magazine or the HC 4 and HC 4 plus chain magazines reduces non-productive times during loading

/// Stable, fully adjustable steady rest with automatic stroke ensures optimal grinding results

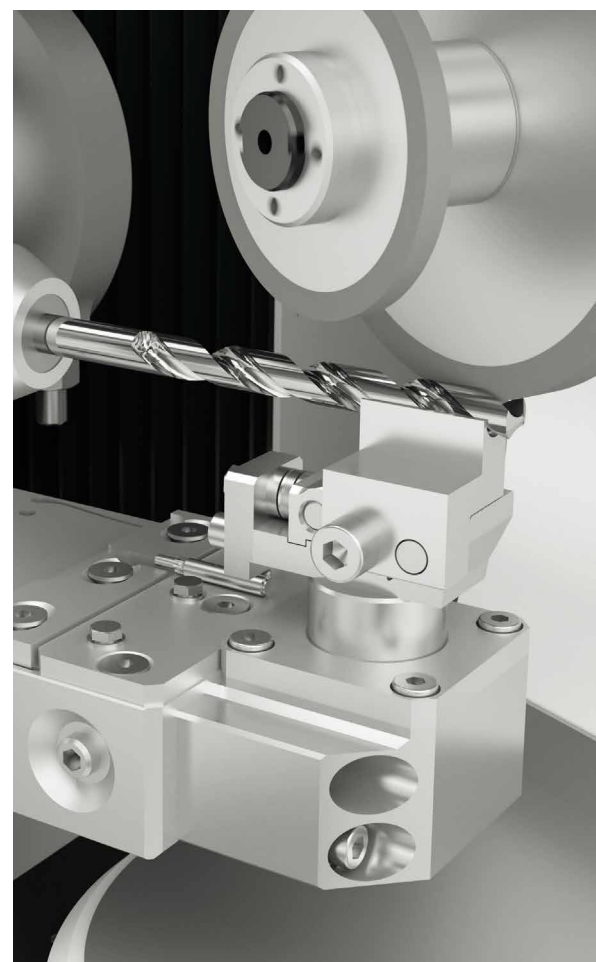

///// STEADY REST WITH AUTOMATIC STROKE
ensures an optimal grinding result
for longer tools

/// THE APPLICATION

The *VGrind 360S* has been designed for productive machining of carbide drills and milling cutters with diameters of up to 32 mm. Depending on the machine kinematics and the tipping of the grinding wheel packages, tools with diameters of up to 200 mm are also possible.

The high flexibility provided by the possibility to change both grinding wheel packages, the reduced changing times thanks to the positively guided system and the practical automation options, combined with the high torque at the bottom spindle for fluting operations, provide the best prerequisites for efficient and high-quality manufacturing.

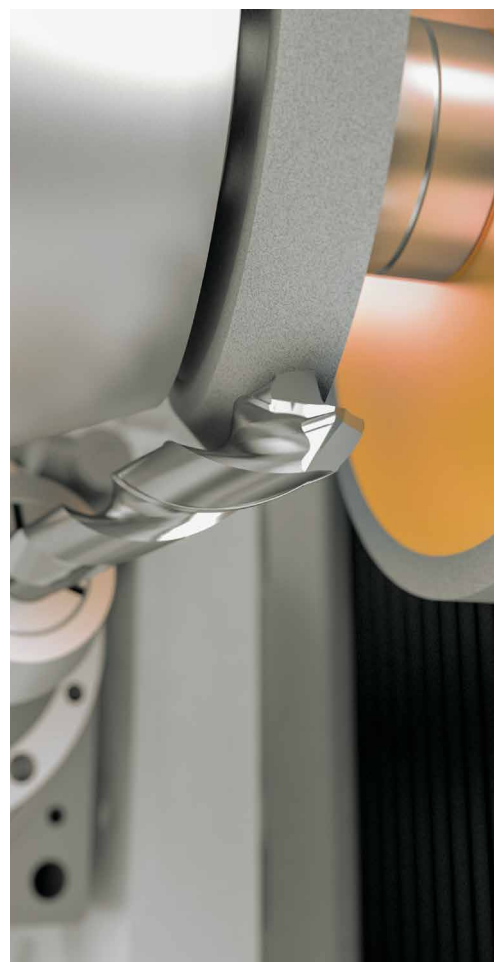
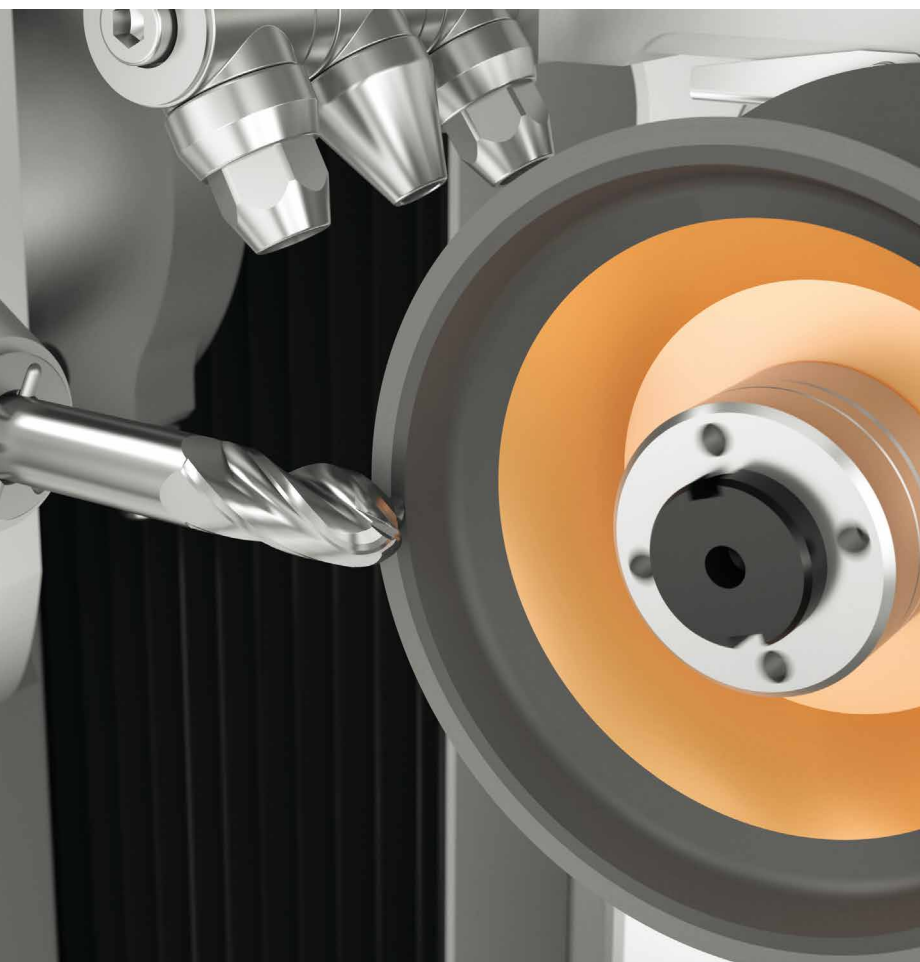

///// MACHINING CARBIDE MILLING CUTTERS

///// MACHINING CARBIDE DRILLS

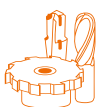

MAXIMUM PRECISION

////// For productive machining of carbide tools of up to 32 mm.
Machining of tools up to 200 mm is possible.

up to 200 mm →

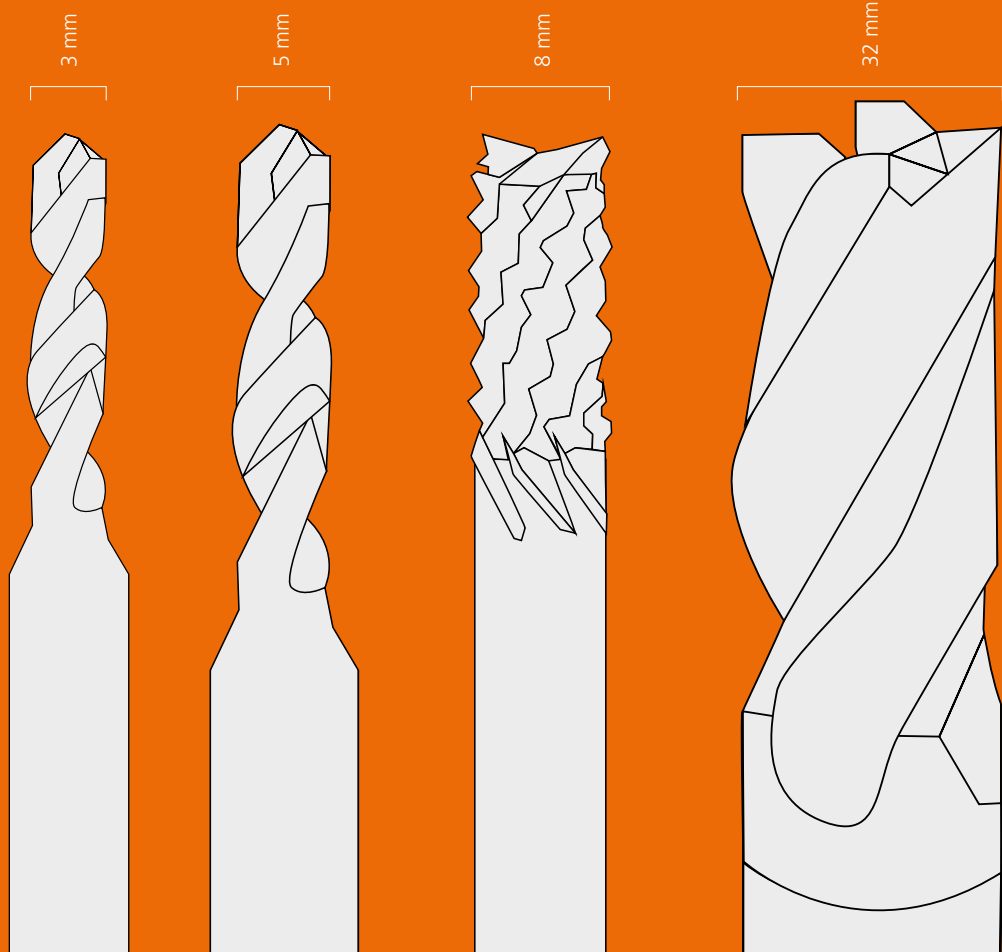

// THE OPERATING CONCEPT

In order to be able to exploit the full potential of your **VGrind 360S**, simple and intuitive operation is vital. This begins with the control panel, which is positioned on the **VGrind 360S** so that not only the LCD display, but also the working area can always be observed in the best possible manner. Operation via the keyboard or touchscreen allows for precise machining of the tool.

The multifunction handwheel ensures even more flexibility: It can be freely positioned on the enclosure and is designed for setting a required axis – without using the control panel. In short: With the **VGrind 360S**, it becomes a pure delight to achieve the best results.



///// ERGONOMIC OPERATION

Flexibly height-adjustable, swivelling control panel, variable multifunction handwheel, optimal view into the machine, easy access to grinding spindles

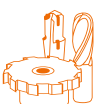



// SOFTWARE NUMROTOPLUS®

VOLLMER consciously opted for a well known software system that is already established on the market. The logically structured interface guarantees intuitive handling. With established programming systems, a huge variety of tools can be manufactured and resharpened. You can change any detail of your tools and adapt them to your individual requirements.

Fully informed: Thanks to a perfect 3D simulation of the tool and machine. And with collision monitoring, you can always stay on the safe side.

- /// Develop
- /// Simulate
- /// Monitor
- /// Produce
- /// Measure
- /// Resharpen
- /// Document

////// PROVEN NUMROTOplus®
SOFTWARE SYSTEM

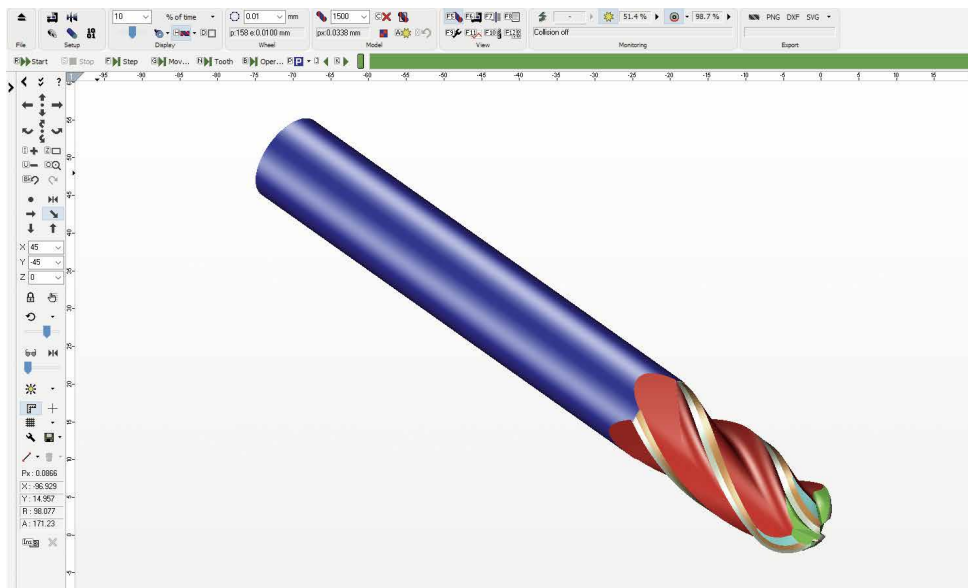

////// PROGRAMMING
of various tools

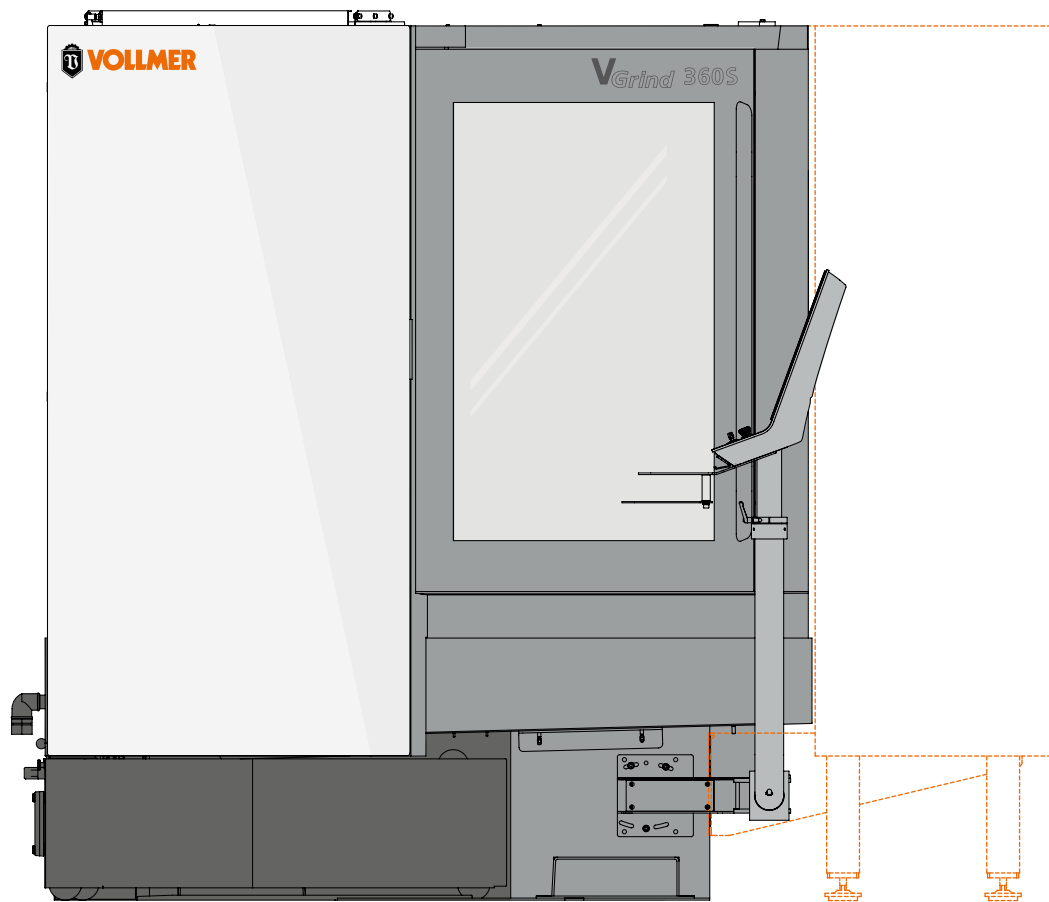

///// TOOL AUTOMATION
A wide variety of automation solutions can be attached

// AUTOMATION

Work process automation is one of the key factors of modern tool production. With the **VGrind 360S**, you can choose from a range of excellent equipment options. This allows you to implement large batches of your tools and to make your manufacturing processes quicker, safer and more precise.

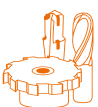

///// ROTARY TOOLS // AUTOMATION

// TOOL AUTOMATION

The various automation options that we offer enable you to optimally adjust the *VGrind 360S* to your requirements.

/// HP 170 pallet magazine with compact pallets (for up to 900 workpieces) and double gripper to guarantee a quick change between short machining times

/// HPR 250 free-arm robot: Allows for the automatic machining of tools with various shaft diameters

/// The HC 4 chain magazine has space for 39 HSK-A63 tools in a compact design or, optionally, up to 158 shank-type tools

// The HC 4 plus – for bigger tasks. Space for up to 160 shank-type tools or 40 HSK 63 tool holders with a tool diameter of 80 mm. With larger tool diameters of up to 150 mm, there is space for 20 HSK 63 tool holders.

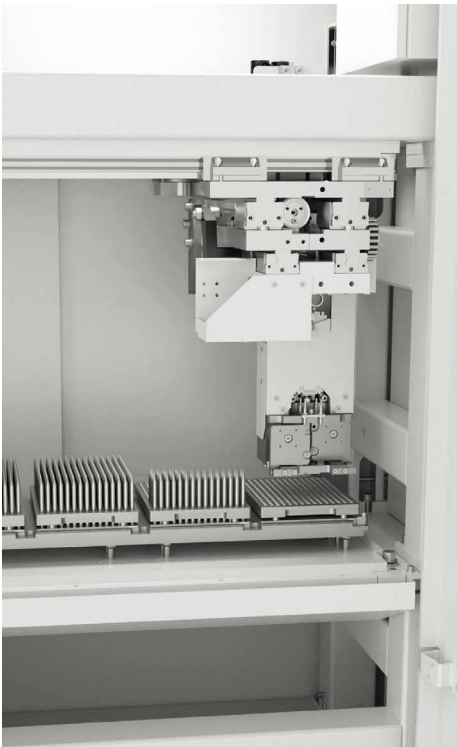

///// HP 170 PALLET MAGAZINE
for the quick supply of up to
900 tools



///// HPR 250 FREE-ARM ROBOT
for increased capacity and
even greater flexibility

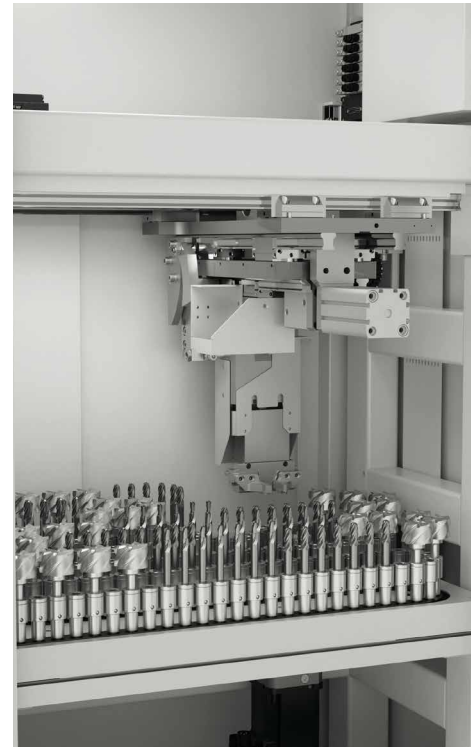

///// HC 4 AND HC 4 PLUS CHAIN MAGAZINE
in compact design

// AUTOMATION

/// EIGHT-TOOL GRINDING-WHEEL CHANGER

Always supply the right grinding wheel – with no manual intervention required: The optimum automation system for eight grinding wheel sets. As an option, coolant nozzles can be automatically exchanged with the wheel sets on both spindles. This is a vital contribution to productivity within your manufacturing process.

/// The oriented spindle holder automatically positions the new grinding wheel packages in the same location on the grinding spindle. This reduces planing and run-out errors and therefore increases the tool's precision.



///// EIGHT-TOOL GRINDING-WHEEL CHANGER
for efficient grinding wheel replacement and
reduced non-productive time

///// EIGHT-TOOL GRINDING-WHEEL CHANGER
including coolant nozzles

// SPECIFICATIONS

TOOL

Outside diameter of up to 200 mm*
Tool length of up to 360 mm**

GRINDING WHEEL

Max. diameter of 150 mm***

GRINDING SPINDLES

	Belt spindle	Belt spindle	Motor spindle
Speed	8500 rpm	6500 rpm	16,000 rpm
Drive output 100% duty cycle	11 kW	11 kW	10 kW
Peak power	23 kW	23 kW	20 kW
Torque	17 Nm	25 Nm	9.5 Nm
Spindle ends made of	HSK50***	HSK50***	HSK50***

TRAVERSE RANGES

X1 axis	426 mm
Y1 axis	490 mm
Z1 axis	505 mm
A1 axis	360°, 450 rpm
C1 axis	Optionally 1000 rpm +15° to -200°

CONNECTED LOAD Approx. 19.2 kVA

WEIGHT Approx. 4900 kg net

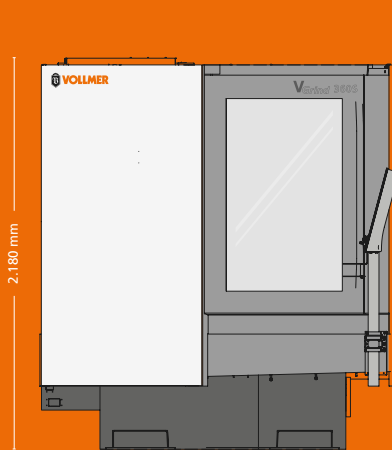

/////// MACHINE DIMENSIONS
VGrind 360S without automation

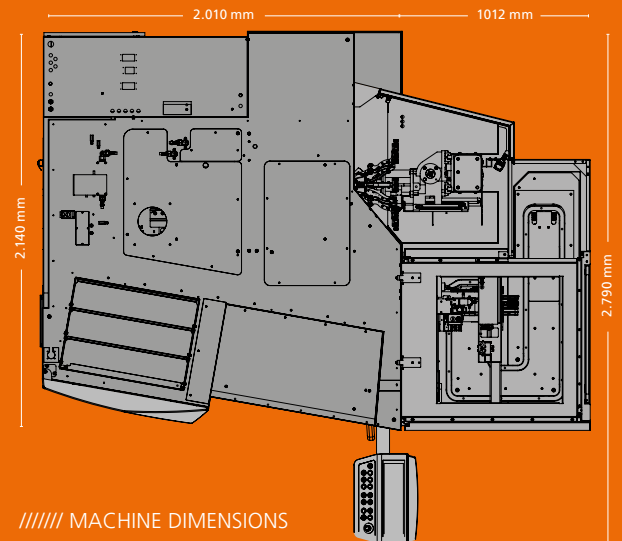

/////// MACHINE DIMENSIONS
VGrind 360S with HC 4 plus

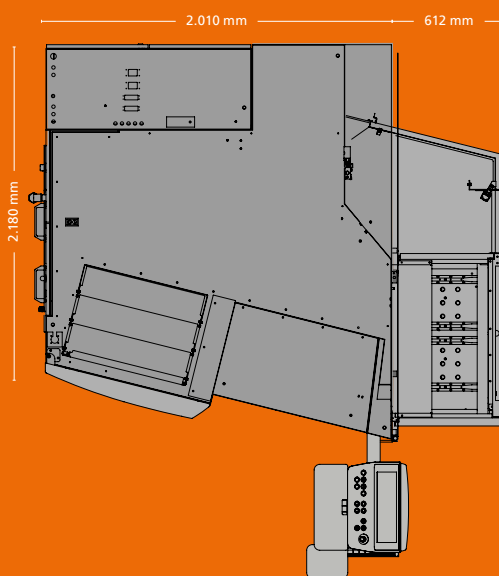

/////// MACHINE DIMENSIONS
VGrind 360S with HP 170 or HC 4

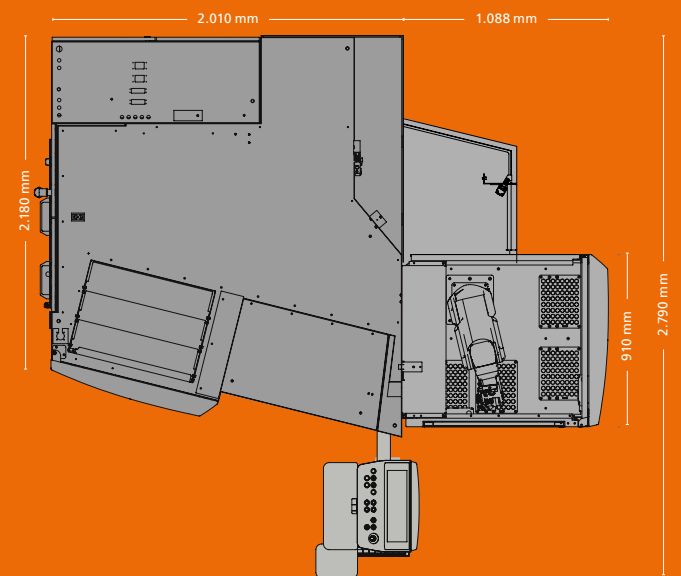

/////// MACHINE DIMENSIONS
VGrind 360S with HPR 250

* Depending on the machine kinematics and equipping.

** From the front edge of the workpiece carrier without measuring the cooling channel.

*** Max. 125 mm with supporting device.

**** Up to three grinding wheels per spindle end.

We reserve the right to make design changes in the interest of technical progress. Patents pending.



V@dison:

DIGITAL SOLUTIONS – PRECISION IN TRANSFORMATION

Do you want to optimise your processes with smart technologies, avoid mistakes and reduce downtimes?

Contact your VOLLMER representative or find out more now at:

www.vollmer-group.com/en/products/digitalisation

VGrind 360S – THE MAIN ADVANTAGES AT A GLANCE:

/// INCREASED PRECISION

Innovative kinematics with multi-layer machining and linear induction motors on the X, Y and Z axes for maximum quality of results. Benefit from uncompromising precision.

/// INCREASED EFFICIENCY

Shorter non-productive times thanks to intelligent and flexible automation. Experience productivity on a new level.

/// INCREASED USER CONVENIENCE

Good accessibility, ergonomically operated control panel and reliable software. Make your work easier.

/// INCREASED FLEXIBILITY

Efficiently machine carbide tools with a diameter of up to 200 mm. For precision in every format you require.

314/en/800/09.23/Holzer