

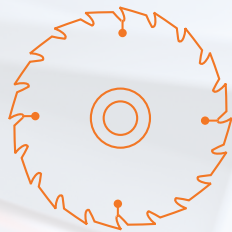

VOLLMER



CHF 840 and CHF 1300

/////// CIRCULAR SAW ///

CNC-controlled machine for grinding tooth sides on carbide-tipped circular saw blades with a diameter of up to 840 or 1300 mm



THE FUTURE IS NOW: CHF 840 and CHF 1300

THE VERSATILITY OF A NEW GENERATION

FIVE CNC-CONTROLLED AXES FOR THE FLEXIBLE AND PRECISE MACHINING OF TOOTH SIDES.

INGENIOUSLY SIMPLE OPERATION WITH INNOVATIVE MULTIFUNCTION HANDWHEEL. GROUND BREAKING MACHINE CONCEPT WITH PROGRAMS USED IN THE WOOD, ALUMINIUM, PLASTIC AND A WIDE RANGE OF METAL APPLICATIONS.

THE RESULT: THE PERFECT COMBINATION OF PRECISION AND PRODUCTIVITY WITH MAXIMUM FLEXIBILITY.

FOR THE UNIVERSAL SIDE MACHINING OF CARBIDE-TIPPED CIRCULAR SAW BLADES WITH A DIAMETER OF 80 MM TO 840 OR 1300 MM

CHF 840 and CHF 1300 ONE FOR ALL. ALL IN ONE.



1 COMPACT DESIGN
Space-saving design and optimal accessibility for operators

4 FULL ENCLOSURE AS STANDARD
For effective safety at work, noise and emission protection, as well as a characteristic appearance

2 INNOVATIVE CONTROL PANEL
With 10-inch LCD colour display and multifunction handwheel for fast and safe operation

5 SOLID DESIGN
Robust machine construction for vibration-free operation and high-quality sharpening result

3 LARGE VIEWING WINDOW
Internal, two-part operational door for a perfect view of the grinding process

Machine available for two different diameter ranges:
80–840 mm or 80–1300 mm



/// THE MACHINE CONCEPT

The CHF series is ideally equipped for sharpening carbide-tipped circular saw blades, offering versatility which leaves nothing to be desired.

/// Five CNC-controlled axes for beginning-to-end hydraulics-free complete machining of all commonly used angles in just one cycle – even for saws with group toothing

/// Oscillation grinding as standard – for high material removal rates in just one cycle, in line with the requirements for production and when replacing teeth during servicing

/// Optimal movement coordination for short grinding times and reduced non-productive times, adjustable feed cam for the ideal tooth positioning

/// Proven VOLLMER drive technology for dynamic and reliable machining

/// Five-axis kinematics for maximum flexibility

/// Automatic central lubrication included in the basic equipment for reduced maintenance effort

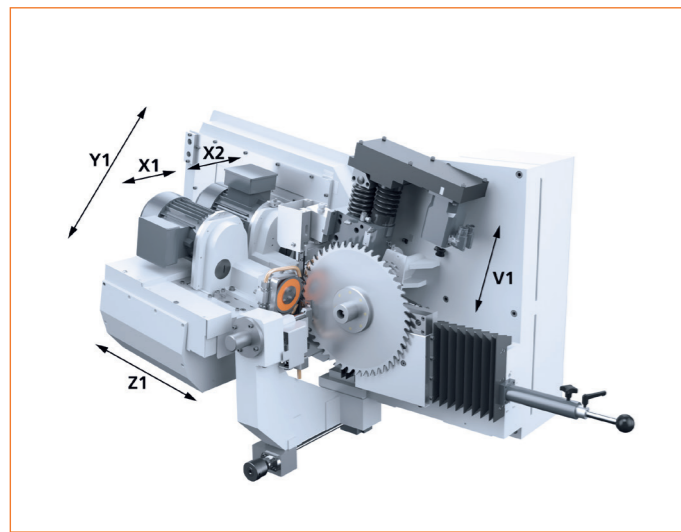

/// MAXIMUM FLEXIBILITY thanks to five CNC-controlled axes (V1, Z1, X1, X2, Y1)

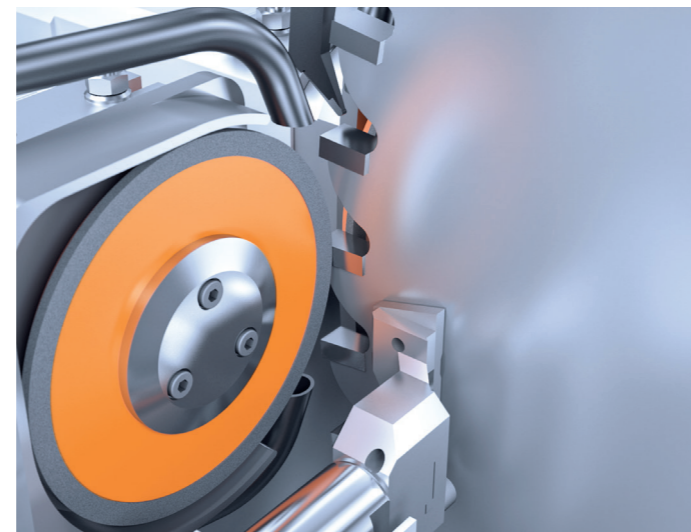

/// SIDE MACHINING

/// APPLICATION

Side grinding of saws for the saw mill industry, woodworking, plastics processing, aluminium processing and metalworking. Its high level of flexibility and superior grinding efficiency make the CHF series the first choice for many applications.

/// Automatic setting of all commonly used angles – including the hook angle – and automatic detection of the tooth pitch

/// Optional: Tooth pitch up to 180 mm thanks to a second feed pawl for greater flexibility, especially in the saw mill

/// Machining of convex tooth flanks also possible

/// Saw change possible without adjusting the mounting carriage – no need to set it up again

/// Optionally available with an even more powerful grinding motor and variable grinding speed for maximum grinding efficiency and optimised machining parameters for the process



/// GRINDING PROGRAM Grind forwards, lift off, followed by a rapid traverse movement



/// GRINDING PROGRAM A rapid forwards movement, feed, followed by a grinding pass back again



/// GRINDING PROGRAM Grind forwards and back again without lift-off



/// OSCILLATION GRINDING Feed and number of strokes can be selected



/// EDGE DIFFERENCE Can be machined on circular saw blades



/// SIDE ANGLE // MACHINABLE TOOTH PROFILE EXAMPLES Convex tooth flanks, positive/negative radial angles (e.g. prescoring circular saws)

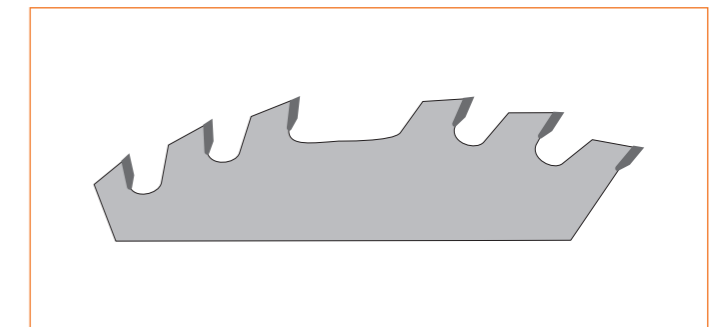

/// GROUP TOOthing can be machined



/// MACHINING A CHIPPER SEGMENT from the saw mill industry



/// THE OPERATING CONCEPT

The multifunction handwheel makes work significantly easier and faster. The axes are selected and controlled by only one module to avoid the possibility of incorrect operation. The handwheel is also used as a potentiometer in order to carry out speed adjustments in automatic mode.

/// Different grinding speeds can be entered depending on requirements: Optimised machining time or maximum surface quality

/// No need for manual adjustment of radial and tangential clearance angles – which means that operating errors are

avoided. Values can be entered as angles or absolute values

/// Fully automated single-sided machining also possible (e.g. for conical prescoring saws)

/// No tooth pitch input required thanks to the feed pawl sensor system

/// Programming, as standard, of special geometries with a flank offset using the multi-surface program

/// SPECIFICATIONS

Circular saws	CHF 840	CHF 1300	
Outside diameter	80–840	80–1,300	mm
Bore diameter	from 10	from 10	mm
Blade thickness	≤ 8	≤ 8	mm
Tooth pitch	≤ 100 (≤ 180*)	≤ 100 (≤ 180*)	mm
Workpiece weight	max. 30	max. 80	kg
Hook angle	-10 to +30	-10 to +30	°
Tangential clearance angle	0 to 8	0 to 8	°
Radial clearance angle	0 to 6	0 to 6	°

(up to -20° machining necessary, possibly single-sided)

Grinding paths	CHF 840	CHF 1300	
Edge	≤ 20	≤ 20	mm
Grinding shaft drive output	0.7 (1.1*)	0.7 (1.1*)	kW
Grinding wheels			
Outside diameter	80–100	80–100	mm
Bore diameter	32	32	mm
Peripheral speed	approx. 18–27**	approx. 18–27**	m/s
Coolant tank capacity	approx. 125	approx. 125	l
Connected load			
(without auxiliary equipment)	approx. 3.7	approx. 3.7	kVA
Weight	approx. 1,680	approx. 1,870	kg

*optional **optional – varies

VOLLMER OPERATION PHILOSOPHY – ensures maximum convenience of use

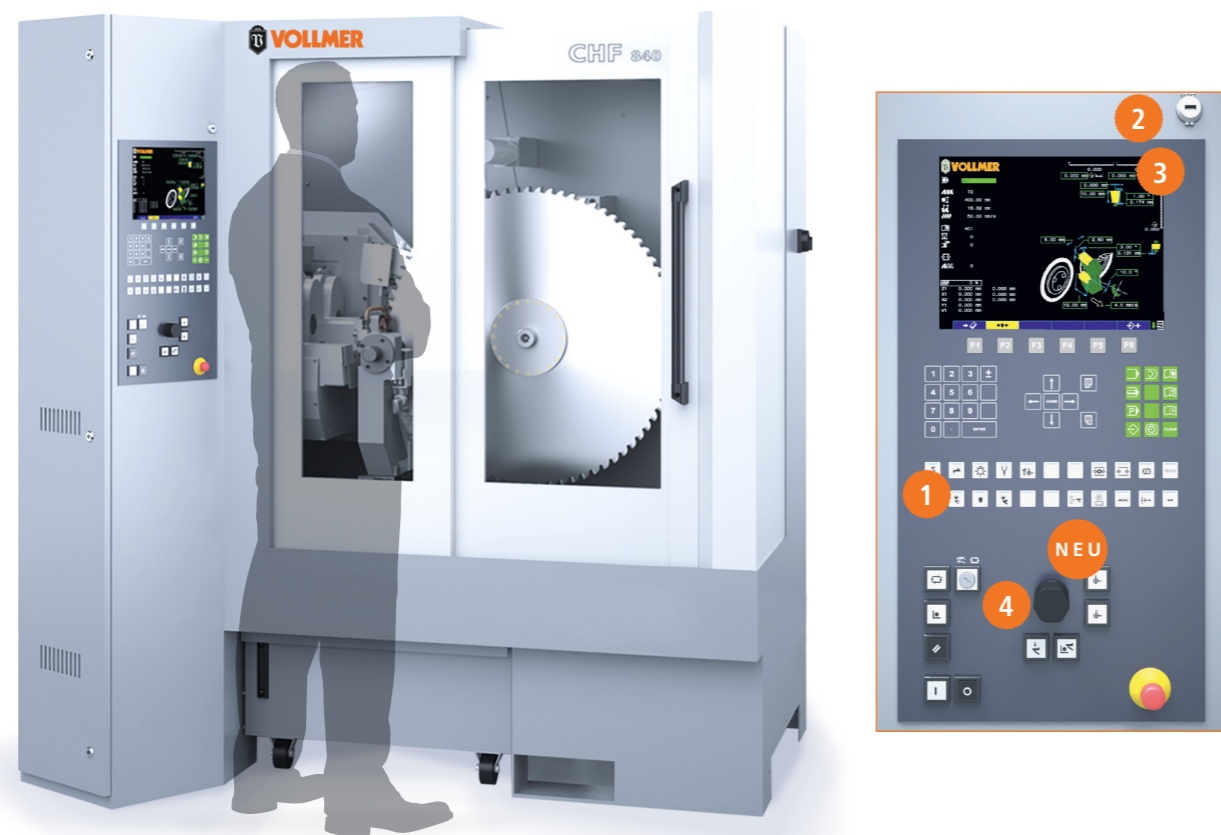

/// 1 CONCISE VOLLMER SYMBOLS facilitate intuitive programming

/// 2 STORAGE of up to 4000 programs possible

/// 3 WINDOWS-BASED INTERFACE with 10-inch LCD colour display and graphical user guidance

/// 4 EASY SET-UP thanks to innovative multifunctional handwheel

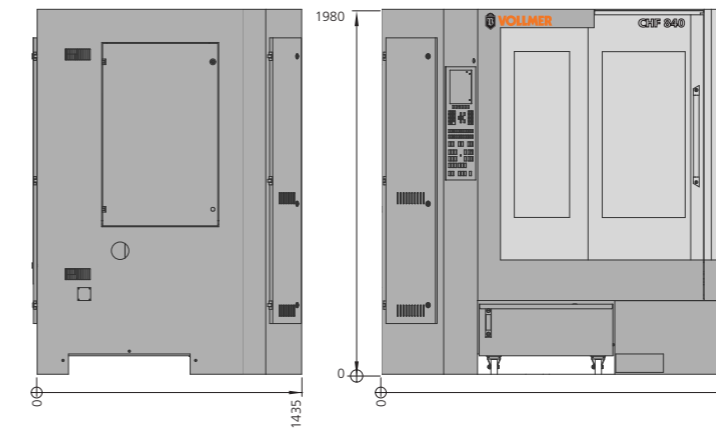

/// MACHINE DIMENSIONS

/// MACHINE FOR TWO DIAMETER RANGES: 80–840 mm or 80–1300 mm available

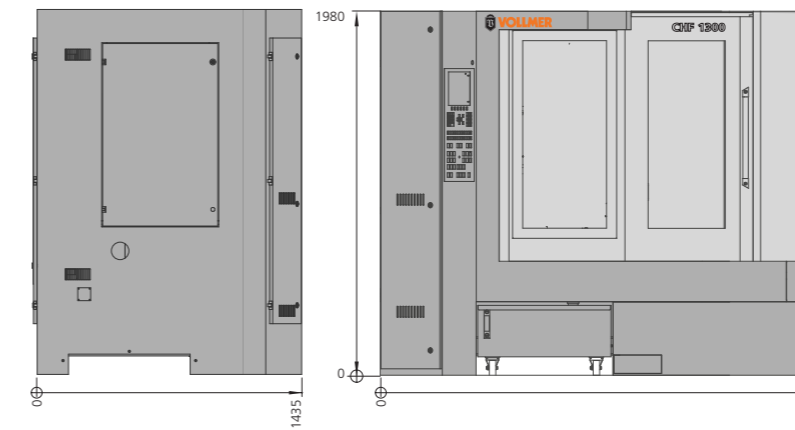

/// SERVICE THAT IS MADE TO MEASURE

With a comprehensive range of helpful and efficient services, VOLLMER is there to provide you with support. From competent advice and the best financing for you, through to an advantageous service contract that allows you to decide now which service costs you will have to pay in the future.

In short: We do everything so that you can concentrate on what's important: Your success.

/// Extensive advice and project planning

/// Financing and insurance

/// Training and start-up

/// Maintenance and service

/// Original spare parts

/// Upgrade and software

/// Purchase and sale of used machines



CHF 840 AND CHF 1300 – THE MAIN ADVANTAGES AT A GLANCE:

/// MORE PRODUCTIVITY

Optimised grinding times, incredible machining precision, outstanding operating comfort and convenience

Your bonus in terms of efficiency and precision

/// INCREASED COST EFFICIENCY

High performance under extremely equitable conditions

Manageable investment – high profitability

/// MAXIMUM FLEXIBILITY

Five CNC axes. No need for manual adjustments.

Machining procedure can be programmed exactly as required

This gives even more opportunities